

Summit Medical®

ENT

Ear, Nose and Throat Products





Elevating Care. Improving Outcomes.

Innovia Medical is a worldwide manufacturer of medical devices across the specialty surgery spectrum including:

- Aesthetic & Reconstructive
- Ear, Nose & Throat
- Dermatology
- General & Vascular
- Gynecology
- Neurosurgical
- Ophthalmic
- Orthopedic
- Personal Protective Equipment
- Sterile Processing

Innovia Medical exports to over 80 countries worldwide. Every Innovia Medical company is passionately committed to partnering with medical professionals to help elevate the delivery of care and improve patient outcomes.

Summit Medical

Summit Medical works closely with healthcare professionals to develop unique, patented products that improve surgical outcomes, make healthcare more efficient, and meet industry demands through all stages of design, engineering, and manufacturing.

Network Medical

Network Medical has 20+ years of experience designing and manufacturing medical products for the ophthalmic and ENT sectors. They work with industry leaders to develop quality products sold in over 72 countries.

Eagle Labs

Eagle Labs continually strives to offer high quality and cost-effective single-use medical devices to the Ophthalmic Medical Community. Their products are manufactured in the USA and delivered to customers through a worldwide network of distributors.

DTR Medical

DTR Medical specializes in the design and manufacture of sterile single-use surgical instruments that deliver both patient and clinical value. Exporting to over 30 countries, they built their award-winning reputation with high-quality, innovative products and exceptional customer service.

Learn more at www.innoviamedical.com.

TABLE OF CONTENTS

ENT PRODUCTS

RHINOLOGY

Denver Splints	4-5
Thermoplast Nasal Splints	6
Internal Nasal Splints	
Nasal Septal Buttons	7
Breeze Nasal Splints	7
Bi-Valve Nasal Splints	7
Shikani Stents	8
Nasal Pack Accessories	
Dale Nasal Dressing Holder	8
Braided Nasal Drip Pad	8
Nasal and Sinus Packs	
AbsorENT Packs	9
Rhino Rocket	10
Epistaxis Catheters	10
Atomizers and Powder Blower	
Devilbiss ENT Therapy	11
Atomizer	11
Powder Blower	11
RhinoGuard	12
Cauteries	12

OTOLOGY

Ventilation Tubes	13-19
Myringotomy Blades	
MicroEdge Blades	20
Flatstock Blades	21
Flatstock Knives	22
Delivery Devices	
Apdyne Phenol Applicator Kit	23
PhenolPro Safety Applicator	23
GVPRO Gentian Violet Applicator	23
MicroWick Drug Delivery	24
AbsorENT Ear Packs and Wicks	25
Suction Devices	
VacuTIP Suction Tips	26
Vacutract Suction Devices	26
Baron Suction	26
Sinus Packing & Splint Cross Reference	27

SUBMIT PURCHASE ORDERS TO:

Summit Medical LLC
815 Vikings Parkway, Suite 100
St. Paul, MN 55121 | USA

P: 1-888-229-2875 | +1 651-789-3939
F: 1-888-229-1941 | +1 651-789-3979
www.summitmedicalusa.com

DENVER SPLINT® - TWO PIECE

Denver Splint® Series 1500

- Soft moldable aluminum and Velcro™
- Length of wear 7-10 days

PART NO.	DESCRIPTION	DIMENSIONS	QTY/BOX
10-1500-05KM	Mini	50mm x 28mm	Kit 5/box
10-1500-05KP	Petite	50mm x 30mm	Kit 5/box
10-1500-05KS	Small/Medium	65mm x 35mm	Kit 5/box
10-1500-05KL	Large	69mm x 43mm	Kit 5/box
10-1500-10NKM	Mini	50mm x 28mm	Non-kit 10/box
10-1500-10NKP	Petite	50mm x 30mm	Non-kit 10/box
10-1500-10KNKS	Small/Medium	65mm x 35mm	Non-kit 10/box
10-1500-10NKL	Large	69mm x 43mm	Non-kit 10/box

Denver Splint® Series 5000

- Soft moldable aluminum and Velcro™ with attached dorsal pad
- Length of wear 7-10 days

PART NO.	DESCRIPTION	DIMENSIONS	QTY/BOX
10-5000-05KM	Mini	50mm x 28mm	Kit 5
10-5000-05KP	Petite	50mm x 30mm	Kit 5
10-5000-05KS	Small/Medium	65mm x 35mm	Kit 5
10-5000-05KL	Large	69mm x 43mm	Kit 5
10-5000-10NKM	Mini	50mm x 28mm	Non-kit 10
10-5000-10NKP	Petite	50mm x 30mm	Non-kit 10
10-5000-10NKS	Small/Medium	65mm x 35mm	Non-kit 10
10-5000-10NKL	Large	69mm x 43mm	Non-kit 10

Denver Splint® Series 1800

- Soft moldable aluminum and Velfoam
- Length of wear 7-10 days

PART NO.	DESCRIPTION	DIMENSIONS	QTY/BOX
10-1800-05KM	Mini	50mm x 28mm	Kit 5
10-1800-05KP	Petite	50mm x 30mm	Kit 5
10-1800-05KS	Small/Medium	65mm x 35mm	Kit 5
10-1800-05KL	Large	69mm x 43mm	Kit 5
10-1800-10NKM	Mini	50mm x 28mm	Non-kit 10
10-1800-10NKP	Petite	50mm x 30mm	Non-kit 10
10-1800-10NKS	Small/Medium	65mm x 35mm	Non-kit 10
10-1800-10NKL	Large	69mm x 43mm	Non-kit 10

DENVER SPLINT® - ONE PIECE

Denver Splint® Series 2000

- Soft moldable aluminum and 1/8" ventilating foam
- Length of wear 5-7 days

PART NO.	DESCRIPTION	DIMENSIONS	QTY/BOX
10-2000-05KM	Mini	50mm x 28mm	Kit 5
10-2000-05KP	Petite	50mm x 30mm	Kit 5
10-2000-05KS	Small/Medium	65mm x 35mm	Kit 5
10-2000-05KL	Large	69mm x 43mm	Kit 5
10-2000-10NKM	Mini	50mm x 28mm	Non-kit 10
10-2000-10NKP	Petite	50mm x 30mm	Non-kit 10
10-2000-10NKS	Small/Medium	65mm x 35mm	Non-kit 10
10-2000-10NKL	Large	69mm x 43mm	Non-kit 10

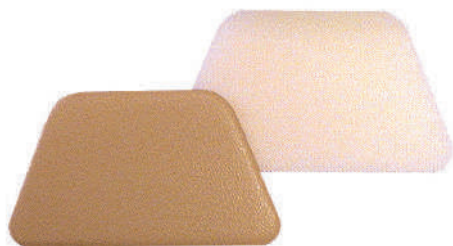
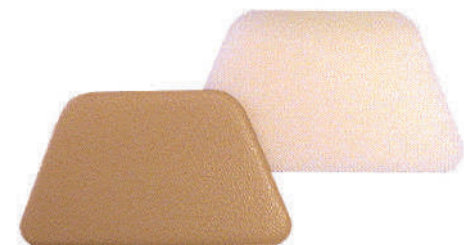

THE 60 SECOND DENVER SPLINT

SPLINTING STEPS TWO PIECE



1. Alcohol & Skin Prep



2. Protecto Tape



3. Dorsal Pad



4. Adhesive Velcro



5. Aluminum Splint



- Adhesive
- Moldable aluminum
- No water mess
- Approximately 60 seconds to apply
- Inconspicuous
- Water resistant

- Stabilization of the nose after surgery
- Reduction of edema after nasal surgery or trauma
- Moldable aluminum retains nasal bones in position
- Layers give cushioned pressure on subcutaneous tissue
- Dorsal pad reduces dead space and possibility of polybeak
- Four sizes: Mini, Petite, Small/Medium, Large
- Kit or Non-Kit

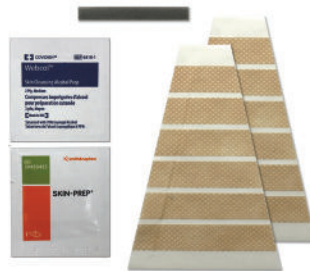

Kit Includes:

- One Denver Splint®
- Two Pre-cut Protecto Strips, sterile
- One alcohol wipe, sterile
- One skin prep, sterile
- One dorsal pad

THERMOPLAST NASAL SPLINTS

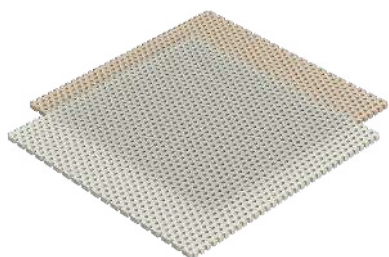

THERMOPLAST SHEETS

- Rigid, opaque, lightweight material
- Soften with hot water and mold over taped nose

Options Available:

- Pre-cut Denver Splint® sizes
- 3x3" Flats
- 9x12" Sheets to cut your own shape



3x3" Squares

PART NO.	DESCRIPTION	QTY
AQ-F-05-21	Ivory 1/16"	5/box
AQ-F-10-21	Ivory 1/16"	10/box
AQ-F-05-31	Ivory 3/32"	5/box
AQ-F-10-31	Ivory 3/32"	10/box
AQ-F-05-22	Blush 1/16"	5/box
AQ-F-10-22	Blush 1/16"	10/box

9x12" Sheets

PART NO.	DESCRIPTION	QTY
AQ-9x12-21	Ivory 1/16"	1
AQ-9x12-31	Ivory 3/32"	1
AQ-9x12-22	Blush 1/16"	1

PRE-CUT THERMOPLAST DENVER SPLINT SIZES

PART NO.	SIZE	DESCRIPTION	QTY/BOX
10-4021-05KL	Large	Ivory 1/16"	Kit, 5
10-4021-05KM	Mini	Ivory 1/16"	Kit, 5
10-4021-05KP	Petite	Ivory 1/16"	Kit, 5
10-4021-05KS	Small	Ivory 1/16"	Kit, 5
10-4021-10NKL	Large	Ivory 1/16"	Non-Kit, 10
10-4021-10NKM	Mini	Ivory 1/16"	Non-Kit, 10
10-4021-10NKP	Petite	Ivory 1/16"	Non-Kit, 10
10-4021-10NKS	Small	Ivory 1/16"	Non-Kit, 10
10-4022-05KL	Large	Blush 1/16"	Kit, 5
10-4022-05KM	Mini	Blush 1/16"	Kit, 5
10-4022-05KP	Petite	Blush 1/16"	Kit, 5
10-4022-05KS	Small	Blush 1/16"	Kit, 5
10-4022-10NKL	Large	Blush 1/16"	Non-Kit, 10
10-4022-10NKM	Mini	Blush 1/16"	Non-Kit, 10
10-4022-10NKP	Petite	Blush 1/16"	Non-Kit, 10
10-4022-10NKS	Small	Blush 1/16"	Non-Kit, 10
10-4031-05KL	Large	Ivory 3/32"	Kit, 5
10-4031-05KM	Mini	Ivory 3/32"	Kit, 5
10-4031-05KP	Petite	Ivory 3/32"	Kit, 5
10-4031-05KS	Small	Ivory 3/32"	Kit, 5
10-4031-10NKL	Large	Ivory 3/32"	Non-Kit, 10
10-4031-10NKM	Mini	Ivory 3/32"	Non-Kit, 10
10-4031-10NKP	Petite	Ivory 3/32"	Non-Kit, 10
10-4031-10NKS	Small	Ivory 3/32"	Non-Kit, 10

Kit Includes:

- One Denver Splint®
- Two Pre-cut Protecto Strips, sterile
- One alcohol wipe, sterile
- One skin prep, sterile
- One dorsal pad

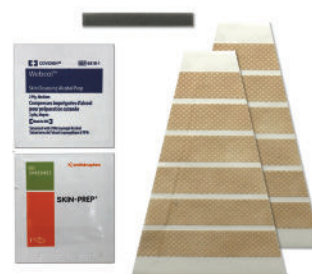

Indicate Size:

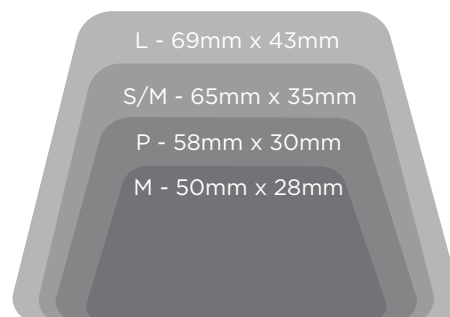

INTERNAL NASAL SPLINTS

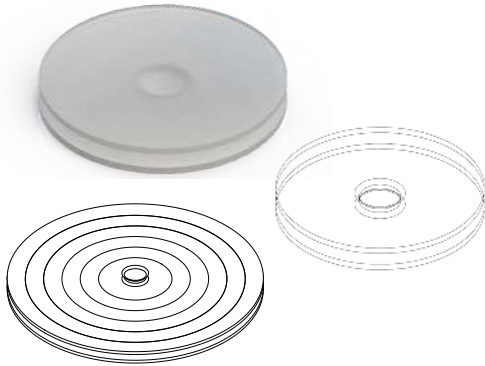

NASAL SEPTAL BUTTONS

One-piece design with 2 flange leaves for maximum security and cleanliness. Designed to reduce or eliminate many symptoms of nasal septal perforations. Easily trimmed to ensure proper fit. Medical-grade silicone. 6mm posts on all sizes. Sterile, single-use.

PART NO.	DESCRIPTION	DIMENSIONS	QTY
SP-78100	Small	3cm x 4mm	1
SP-78105	Medium	5cm x 4mm	1
SP-78107	Large	7cm x 4mm	1

***Pre-marked in 1cm increments for easy trimming. Only applies to large size.*



w/Airway



w/out Airway

BREEZE™ NASAL SPLINTS

Unique airway geometry creates a pressure gradient force that increases airflow. Suture indicators are located at anterior tip to aid suture placement. Lubricious coating aids insertion and removal. Sterile, single-use.

- Increase airflow
- Soft medical-grade silicone
- Commonly referred to as "Doyle Splint"

PART NO.	DESCRIPTION	QTY
SP-79300	With Airway, Sterile	1 Pair
SP-79300-05	With Airway, Sterile	5 Pairs
SP-79300-50	With Airway, Sterile	50 Pairs
SP-79200-B	With Airway, Non-Sterile	50 Pairs
SP-79400	Without Airway, Sterile	1 Pair

BI-VALVE NASAL SPLINTS

Non-stick surface reduces adhesion and/or hematoma. Medial slit facilitates insertion and removal. Holes for easier suturing. Sterile, single use. Clear fluoroplastic, medical-grade material.

PART NO.	DESCRIPTION	QTY
SP-27000	Standard Thin (.25mm)	6 Pairs/box
SP-27005	Standard Thick (.5mm)	6 Pairs/box
SP-27010	Oversized Thin (.25mm)	6 Pairs/box
SP-27015	Oversized Thick (.5mm)	6 Pairs/box



SHIKANI STENTS

Designed to be placed following functional endoscopic sinus surgery to maintain patency of the middle meatal antrostomy and to reduce or eliminate the need for post-op packing. Sterile, single-use.

- Medical-grade silicone material

PART NO.	DESCRIPTION	A	B	C	D	E	F	QTY/BOX
SP-80010	Small	27.9	5	21.9	6.2	4.6	23.4	6
SP-80020	Medium	37.5	6	29.5	7.8	4.6	23.4	6
SP-80030	Large	39	8.1	29.5	9.3	4.6	23.4	6

Developed and refined in use at Johns Hopkins Hospital by Dr. Alan Shikani.

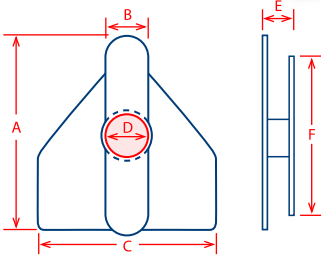

NASAL PACK ACCESSORIES



DALE NASAL DRESSING HOLDER

Eliminates skin irritation and simplifies dressing changes, improves patient comfort, and saves nurse time. It can be custom-fitted by moving the ear loops along the surface of the dressing holder to achieve the desired length between nose and ear. One size fits all. Latex free. Single use.

PART NO.	DESCRIPTION	QTY
DA-600	Nasal Dressing Holder	10

BRAIDED NASAL DRIP PAD

The Nasal Drip Pad is an easy to use, absorbent, disposable pad/roll for nasal surgeries including, sinuplasty, septoplasty, and rhinoplasty. Nasal Drip Pads are also a perfect solution for “nosebleeds” and “runny noses.”

Nasal Drip Pads are manufactured with highly absorbent cotton, wrapped in an overlay for comfort. The cotton roll is affixed to stretchable ear-loops designed to comfortably and securely hold roll in place.

PART NO.	DESCRIPTION	QTY
BNDP 18-5-20	Nasal Dressing Holder	100



NASAL AND SINUS PACKS

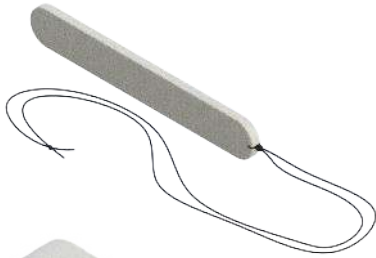

Compressed

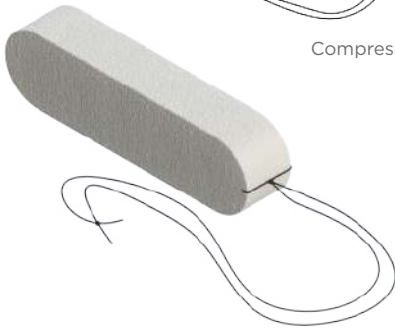

Hydrated

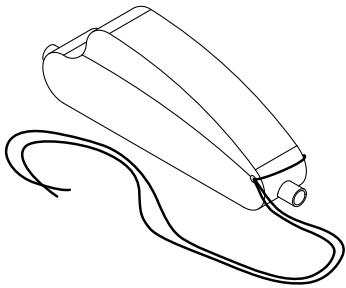

Anatomical with Airway

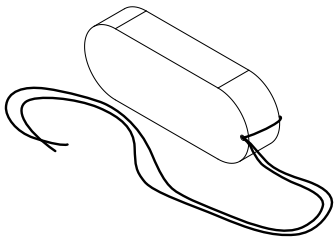

Sinus

ABSORBENT™ NASAL AND SINUS PACKS

AbsorbENT nasal and sinus packs utilize three-dimensional interconnected open cells that are soft and pliable.

- Even and fast expansion
- Soft, lint and fiber free
- Rapid wicking properties

Note : Dimensions listed are for hydrated state.

PART NO.	SIZE	DIMENSIONS LxWxH (CM)	QTY
RH-2315-20	Small	5.5 x 1.5 x 2	20
RH-7401-10	Small	4.5 x 1.5 x 2	10
RH-7408-10	Small with Airway	4.5 x 1.5 x 2	10
RH-7404-10	Large	8 x 1.5 x 2	10
RH-7405-10	Large with Airway	8 x 1.5 x 2	10
RH-7409-10	Large Anatomical	8 x 1.5 x 3	10
RH-7410-10	Large Anatomical with Airway	8 x 1.5 x 3	10
RH-7411-10	Large Anatomical - Thin	8 x 1 x 3	10
RH-7406-10	Large - Thin	8 x 1 x 2	10
RH-2310-10	Extra Large	10 x 1.5 x 2.5	10

SINUS PACKS

PART NO.	DESCRIPTION	DIMENSIONS LxWxH (CM)	QTY
RH-7530-10	Sinus, 6W	3.5 x 1.2 x 0.6	10
RH-7532-10	Sinus, 6W	3.5 x 1.2 x 0.9	10



RHINO ROCKET®

- Sterile PVA foam
- Epistaxis management after trauma, nasal or sinus surgery
- Gentle but firm mucosal compression
- Tamponade of anterior or middle segment epistaxis
- 30 Seconds to position and insert
- Foam swells to six times its compressed diameter
- String attached for retention and ease of removal
- Dimensions listed are for hydrated state and for insertion position

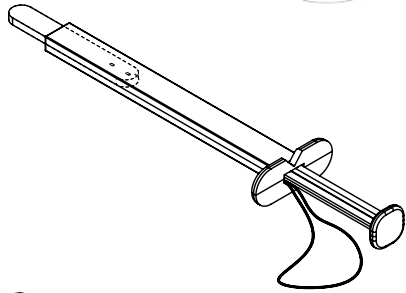

SLIMLINE

PART NO.	SIZE	DIMENSIONS LxWxH (CM)	QTY
11S-S0300-08AS	Small	3 x 1 x 2	8
11S-S0500-08AS	Medium	5 x 1 x 2	8
11S-S0800-08AS	Large	8 x 1 x 2	8
11S-S1000-08AS	Extra Large	10 x 1 x 2	8

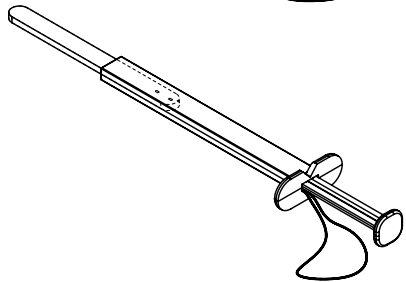

WIDELINE

PART NO.	SIZE	DIMENSIONS LxWxH (CM)	QTY
11W-W0300-08AS	Small	3 x 1.5 x 2	8
11W-W0500-08AS	Medium	5 x 1.5 x 2	8
11W-W0800-08AS	Large	8 x 1.5 x 2	8
11W-W1000-08AS	Extra Large	10 x 1.5 x 2	8

STARTER PACK

PART NO.	DESCRIPTION	QTY
11S-STARTERRHINO	Variety pack with one of each size.	8/box

EPISTAXIS® CATHETERS

Double balloon catheter made from soft, medical-grade silicone, designed to control intranasal bleeding. Allows for control of anterior and/or posterior nasal bleeding. Available with or without Syringe. Made from soft, medical-grade silicone. Sterile. Single-use.



Inflated



Deflated

PART NO.	SIZE	DESCRIPTION	QTY/BOX
RH-4200-01	97mm	No Syringe	1
RH-4200-10	97mm	No Syringe	10
RH-4220-01	97mm	With 20cc Syringe	1
RH-4400-01	102mm	No Syringe	1
RH-4400-10	102mm	No Syringe	10
RH-4420-01	102mm	With 20cc Syringe	1

DEVILBISS® ENT THERAPY

DeVilbiss atomizers offer conventional consistent sprays for aqueous or viscous solutions. Available in a variety of models.



ATOMIZER

Applies a very fine mist to nasal cavities. Features include:

- Amber glass body
- Top constructed of polypropylene material for spraying solutions incompatible with metal
- Ultra-fine particle atomization of most medical solutions
- Straight flow tip is easily disassembled for cleaning

PART NO.	DESCRIPTION	QTY
DV-286	DeVilbiss Model 286-RD	1



ATOMIZER

Offers a consistent spray for aqueous or viscous solutions. Features include:

- Adjustable tip to direct fine spray precisely where needed
- All-metal top is autoclavable
- Oil or water solutions compatible with rhodium plating can be used

PART NO.	DESCRIPTION	QTY
DV-15	DeVilbiss Model 15-RD	1



POWDER BLOWER

Ideal for applying an even diffusion of any powder to nose, throat or ear. Features include:

- Curved spray tube for ease and convenience of applications

PART NO.	DESCRIPTION	QTY
DV-119	DeVilbiss Model 119	1

OTHER MODELS AVAILABLE:

PART NO.	DESCRIPTION	QTY
DV-177	Syringe Model 177	1

Atomizers, Nebulizers, Powder Blowers and Irrigation syringe are distributed in the US by Summit Medical and are products of DeVilbiss® Healthcare.



RHINO GUARD™

The RhinoGuard™ atomizer tip cover is designed to prevent cross contamination and its associated risks, while the flared shield also reduces splash-back for improved clinician protection. Inexpensive and convenient to use, the disposable RhinoGuard protectors fit the most popular DeVilbiss® Atomizer models: DV-163 and DV-286.

- Precision-molded of soft, flexible polymer
- Helps seal the nasal passage
- Sterile, single-use

A Summit Medical exclusive, the RhinoGuard atomizer tip cover helps keep the atomizer's tip in the correct location during use, helping meet the challenge of treating pediatric and other active patients. Its unique design enables more efficient administration of fine sprays.

PART NO.	DESCRIPTION	QTY
SP-30010	Refill Pack	100
SP-30250	Tips + dispenser box	250

CAUTERIES

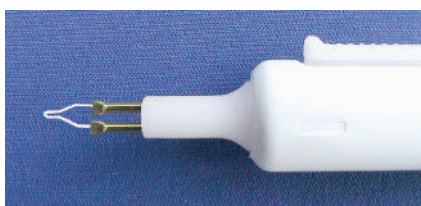

DISPOSABLE HIGH TEMPERATURE CAUTERIES

- Sterile
- Battery operated
- Four-year shelf-life
- Long burn time
- High temperature 2200°F
- Fast from zero to full temperature

PART NO.	DESCRIPTION	QTY
20-HM-1000	Fine Tip	10
20-HM-2000	Loop Tip	10

VENTILATION TUBES

MATERIAL DESCRIPTIONS

Fluoroplastic >> FP / BL (blue) or FP / W (white)

Inert, biocompatible and very smooth. The rigid material facilitates tube insertion and its nonstick characteristics may reduce adhesion formation and/or clogging. Summit Medical uses only 100% certified virgin material.

Silicone Elastomer >> S / BL (blue)

Extremely soft, compliant and elastic material. It is easily manipulated, extremely lubricious, and allows vent tubes to be easily compressed for insertion or removal. Summit Medical uses 100% certified medical grade silicone resin.

Titanium E >> TT

One-half the weight of stainless steel with many of the same features and benefits. It has excellent biocompatibility, is extremely resistant to corrosion and attack by body fluids, its rigidity facilitates insertion and it is extremely durable. Summit Medical uses 100% certified ASTM F136-92 titanium.



DIMENSIONS

Measurements are listed in millimeters (schematic example and KEY below). All ventilation tube dimensions are approximate and subject to manufacturing variances. All ventilation tubes are sterile, single-use unless otherwise noted.

KEY

(example)

A

Inner Diameter

B

Inner Flange Diameter

C

Outer Flange Diameter

D

Inner Flange Distance

E

Total Length

MRI INFORMATION

The titanium vent tube and stainless steel wire have been determined to be MR-conditional according to the terminology specified in the American Society for Testing and Materials (ASTM) International, Designation: F2503-05.

A patient with this device can be scanned safely immediately after placement under the following conditions:

- Static magnetic field of 3 Tesla or less
- Maximum spatial gradient magnetic field of 720-Gauss/cm or less

Additional information can be obtained by contacting Summit Medical at 651-789-3939 or 1-888-229-2875.

Our Vent Tube offering is changing.

To learn more go to
www.summitmedicalusa.com/otology/ventilation-tubes/



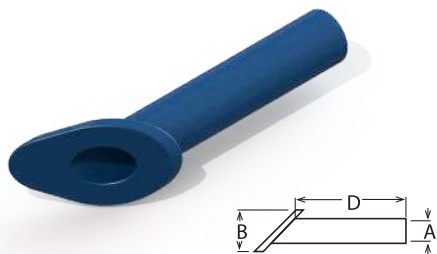

ARMSTRONG BEVELED STRAIGHT SHANK

The angle of the beveled inner flange corresponds to the angle of the tympanic membrane for easier insertion, resistance to premature extrusion, and visibility through the lumen.

PART NO.	FEATURE	MATERIAL	A	B	C	D	E
VT-0500-01	--	S/BL	1.14	2.6	-	7.0	-
VT-0501-01	--	FP/BL	1.14	2.6	-	7.5	-

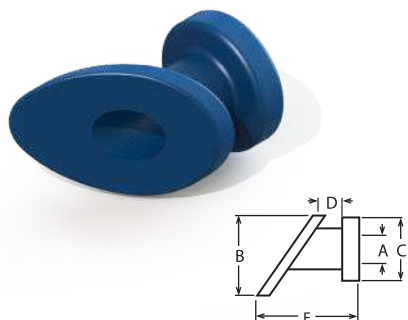

ARMSTRONG GROMMET

Beveled inner flange corresponds to the angle of the tympanic membrane for easier insertion, extrusion resistance, and visibility through the lumen. Outer flange adds security.

PART NO.	FEATURE	MATERIAL	A	B	C	D	E
VT-0503-01	--	FP/BL	1.14	2.5	2.4	1.0	4.0

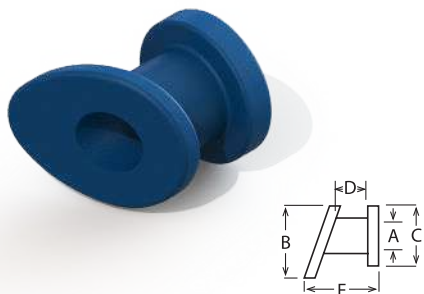

MODIFIED ARMSTRONG GROMMET

Modified angle facilitates insertion into the myringotomy.

PART NO.	FEATURE	MATERIAL	A	B	C	D	E
VT-0508-01	--	FP/BL	1.14	3.07	2.59	1.29	3.07

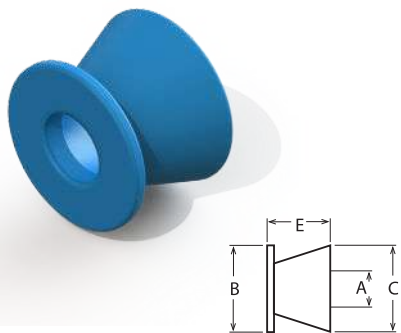

BAXTER BEVEL BUTTON

The beveled shape resists occlusion and clears easily. It permits improved visibility through the lumen. The smaller models are especially useful for small ear canal or pediatric applications.

PART NO.	FEATURE	MATERIAL	A	B	C	D	E
VT-0602-01	--	FP/W	1.27	3.0	3.0	-	2.2
VT-0606-01	--	S/BL	1.27	2.62	1.27	-	2.08

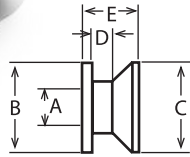
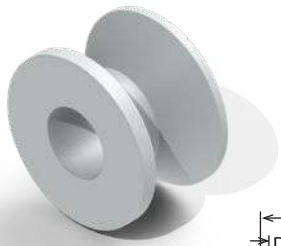

BEVEL BOBBIN

Combining the best features of the Baxter Bevel Button and the Reuter Bobbin, the beveled shape resists occlusion and clears easily.

PART NO.	FEATURE	MATERIAL	A	B	C	D	E
VT-0608-01	--	FP/W	1.14	2.79	2.79	0.66	1.75

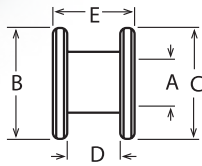

COLLAR BUTTON (SHEEHY STYLE)

Available in fluoroplastic, silicon or titanium, with or without wire, and two inner lumen diameters. These large inner diameter models offer increased drainage and ventilation. Similar to Reuter Bobbin without holes.

PART NO.	FEATURE	MATERIAL	A	B	C	D	E
VT-1001-01	--	FP/W	1.27	2.9	2.9	1.4	2.1
VT-1002-01	--	S/BL	1.27	2.84	2.84	1.43	2.0

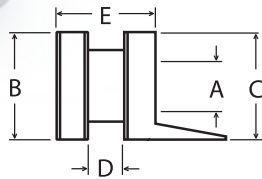
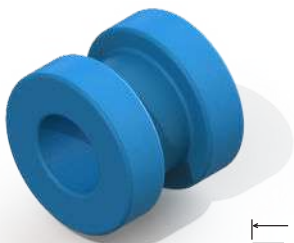

DONALDSON

The large lumen offers good ventilation and the dual flange design resists migration and extrusion. Available with a tab for insertion and removal convenience.

PART NO.	FEATURE	MATERIAL	A	B	C	D	E
VT-0100-01	--	S/BL	1.14	2.4	2.4	0.8	2.2
VT-0101-01	w/tab	FP/W	1.27	2.9	2.9	1.4	2.1
VT-0102-01	--	FP/W	1.14	2.84	2.84	1.43	2.0

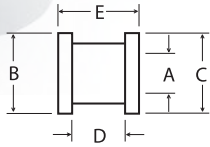

MINI-GROMMET

Dimensioned for pediatric, small ear canal, and tortuous ear canal applications. Mini-Grommet tubes are precision-machined from lightweight, certified titanium.

PART NO.	FEATURE	MATERIAL	A	B	C	D	E
VT-1425-01	--	TT	0.76	1.5	1.5	1.0	1.5

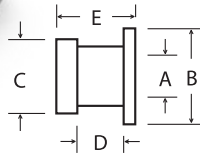

MINI-TEF

Dimensioned for pediatric, small ear canal, and tortuous ear canal applications. Mini-Tef tubes are constructed of white fluoroplastic and feature a larger diameter inner flange.

PART NO.	FEATURE	MATERIAL	A	B	C	D	E
VT-1602-01	--	FP/W	0.86	2.0	1.6	1.0	1.5

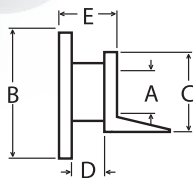
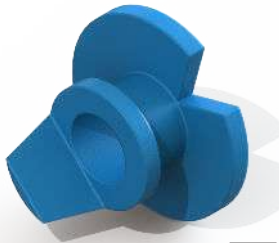

PAPARELLA

Available in two inner lumen and flange sizes (Types I and II), the notched inner flange is designed for a “twist-in” insertion in a smaller incision.

PART NO.	FEATURE	MATERIAL	A	B	C	D	E
VT-0300-01	Type I	S/BL	1.14	2.4	2.1	1.1	2.2
VT-0301-01	Type II	S/BL	1.42	4.4	2.7	1.1	2.2

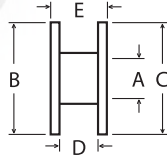

REUTER BOBBIN WITHOUT HOLES

The larger flange diameters encourage longer-term retention. The short flange model is designed to pass through smaller speculums. Available in three lumen diameters. Design is similar to Collar Button design.

PART NO.	FEATURE	MATERIAL	A	B	C	D	E
VT-1203-01	--	FP/W	1.00	2.8	2.8	1.0	1.5
VT-1204-01	--	FP/W	1.14	2.8	2.8	1.0	1.5
VT-1231-01	--	TT	1.14	2.8	2.8	1.0	1.4
VT-1232-01	--	TT	1.27	2.8	2.8	1.0	1.4

SHAH

The tab on the outer flange facilitates insertion and better resists extrusion.

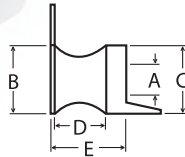

PART NO.	FEATURE	MATERIAL	A	B	C	D	E
VT-0802-01	w/tab	FP/W	1.14	2.4	2.4	-	2.5
VT-0803-01	w/wire	FP/W	1.14	2.4	2.4	-	2.5

SHEPARD

Ease of insertion with forceps or a tube inserter have led to this design's popularity. Available in silicone with a tab or in fluoroplastics with and without wire.

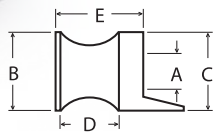

PART NO.	FEATURE	MATERIAL	A	B	C	D	E
VT-0200-01	w/tab	S/BL	1.00	2.4	2.4	1.6	2.4
VT-0202-01	--	FP/W	1.14	2.4	2.4	1.6	2.4
VT-0203-01	w/wire	FP/W	1.00	2.4	2.4	1.6	2.4
VT-0204-01	--	FP/W	1.00	2.4	2.4	1.6	2.4

STRAIGHT SHANK

Smaller inner flange facilitates insertion in a smaller incision. May be cut to length. Longer shaft lengths may help resist water migration into the middle ear.

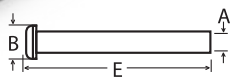
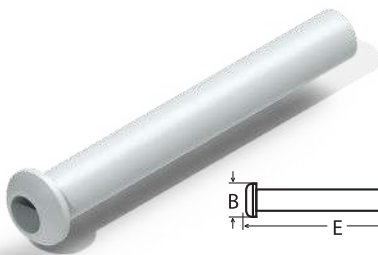

PART NO.	FEATURE	MATERIAL	A	B	C	D	E
VT-0901-01	--	FP/W	1.14	2.2	-	-	7.0
VT-0903-01	--	FP/W	0.89	2.2	-	-	7.0



T-TUBE INSERTER

Facilitates rapid insertion of an length T-Tube. Special push-pin stored in the handle aids in loading T-Tubes.

PART NO.	FEATURE	UNITS/BOX
13-31-40	Non-sterile, reusable	1 inserter

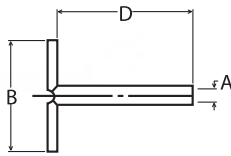
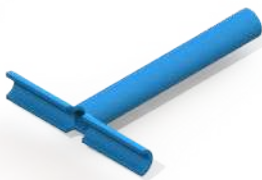

T-TUBE

Most often used for longer-term ventilation, the flexible flanges permit insertion through a smaller incision, stable positioning in the tympanic membrane, and easy removal.

PART NO.	FEATURE	MATERIAL	A	B	C	D	E
VT-0400-01	--	S/BL	1.14	9.8	-	12.0	-
VT-0401-01	--	S/BL	1.14	7.9	-	4.8	-
VT-0406-01	--	S/BL	1.14	4.1	-	4.8	-
VT-0407-01	--	S/BL	1.14	5.6	-	8.0	-

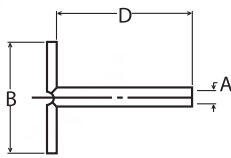
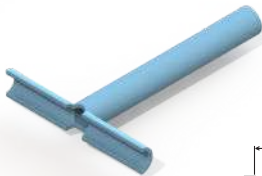

T-TUBE SUPERSOFT

Most often used for longer-term ventilation, the flexible flanges permit insertion through a smaller incision, stable positioning in the tympanic membrane, and easy removal.

PART NO.	FEATURE	MATERIAL	A	B	C	D	E
VT-0409-01	--	S/BL	1.14	9.8	-	12.0	-
VT-0410-01	--	S/BL	1.14	5.6	-	8.0	-

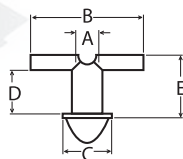
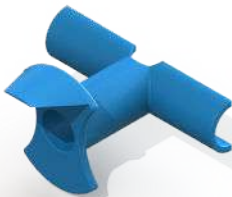

GROMMET T-TUBE

Retaining the advantages of the conventional T-tubes, this larger-lumen design adds a butterfly-shaped grommet with integral tab for ease of insertion and removal.

PART NO.	FEATURE	MATERIAL	A	B	C	D	E
VT-0403-01	--	S/BL	1.27	6.4	3.8	2.4	3.5

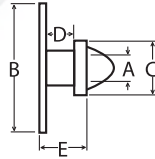
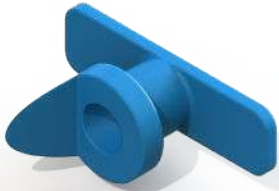

TOUMA T-TUBE

This compact length, longer-term design features flat T-type inner flanges and an outer grommet with integral tab for ease of insertion and removal.

PART NO.	FEATURE	MATERIAL	A	B	C	D	E
VT-0405-01	--	S/BL	1.14	5.8	2.4	1.3	2.1

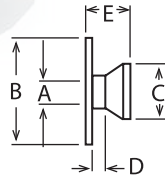
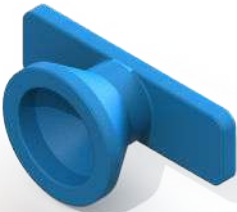

TOUMA II T-TUBE

This compact length, longer-term design features flat T-type inner flanges and an outer grommet with integral tab for ease of insertion and removal.

PART NO.	FEATURE	MATERIAL	A	B	C	D	E
VT-0408-01	--	S/BL	1.12	5.0	2.59	0.63	2.08

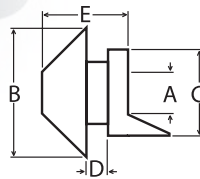
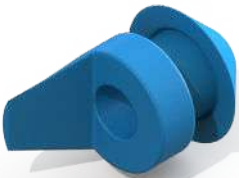

















UMBRELLA

Available in two lumen and flange sizes (Types I and II), the inner flange collapses during insertion through a smaller incision and inverts for convenient removal.











PART NO.	FEATURE	MATERIAL	A	B	C	D	E
VT-0700-01	Type I	S/BL	1.00	2.3	2.3	0.8	3.2

MICROEDGE™ BLADES



These hollow-ground, stainless steel blades produce the thinnest edge possible, for unsurpassed sharpness. Four blade designs are available to meet your needs and preferences. Blades are available in two versions to fit reusable handle styles — collet-style or adaptor-style.

PRODUCT		DESCRIPTION	PART NO.	UNITS/BOX
ARROW BLADES		DOUBLE-CUTTING EDGE:		
		Collet-style	BL-0150	12
		Adaptor-style	BL-1150	12
ARMSTRONG BLADES		DOUBLE-CUTTING EDGE:		
		Collet-style	BL-0160	12
		Adaptor-style	BL-1160	12
BEVEL BLADES		FORWARD CUTTING EDGE:		
		Collet-style	BL-0151	12
		Adaptor-style	BL-1151	12
NARROW ARROW BLADES		COMPACT DOUBLE-CUTTING EDGE:		
		Collet-style	BL-0152	6
		Adaptor-style	BL-1152	6
GUARISCO BLADES		Collet-style	BL-0170	12
				
HANDLES		REUSABLE HANDLES:		
		Collet-style Handle	BL-0425	1
		Adaptor-style Handle	BL-1425	1
	Available for each blade option.			

FLATSTOCK BLADES

PRODUCT	PART NO.	UNITS/BOX
ADULT LANCE BLADE  	BL-2001	6
ADULT LANCE REVERSE BLADE  	BL-2003	6
JUVENILE SPEAR BLADE  	BL-2004	6
JUVENILE LANCE BLADE  	BL-2006	6
TYMPANOPLASTY ANGLED BLADE  	BL-2008	6
HANDLE, FLATSTOCK BLADE  Non-sterile, reusable.	BL-2024	1

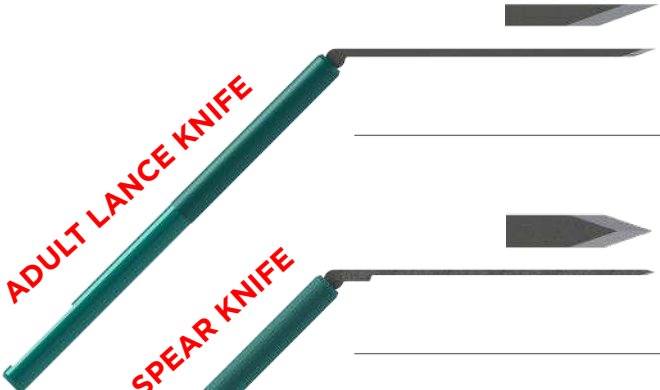
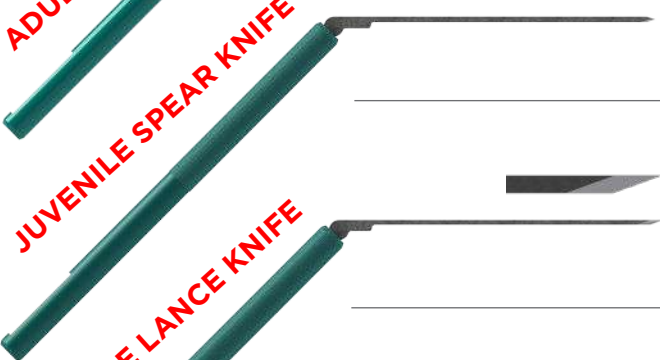
FLATSTOCK KNIVES

PRODUCT	PART NO.	UNITS/BOX
 <p>ADULT LANCE KNIFE</p>	BL-2002	6
 <p>JUVENILE SPEAR KNIFE</p>	BL-2005	6
 <p>JUVENILE LANCE KNIFE</p>	BL-2007	6



ALLIGATOR FORCEPS

- 3 1/2"
- Serrated
- Delicate pattern
- 2 sizes available

PART NO.	SIZE	UNITS/BOX
SI-4860-02E	4mm	1
SI-4860-13E	7mm	1

APDYNE PHENOL APPLICATOR KIT

Use the Apdyne Phenol Applicator Kit to anesthetize the tympanic membrane during myringotomy procedures.

- Provides a fresh unit of phenol and a new applicator for each procedure.
- Conveniently dispose of product after use.
- Applicator eliminates patient discomfort associated with local infiltration.
- Unique foam tip applies the proper dosage of phenol to the incision site for immediate anesthesia.
- Immediate anesthesia enables quick and easy procedures with reliable results.
- Facilitates fast in-office treatment of patients.



PART NO.	DESCRIPTION	UNITS/BOX
15-06	Non-sterile, single-use	6

PHENOLPRO™ SAFETY APPLICATOR

All-in-one, self contained, double-barrier vial containing .27ml of phenol integrated into the handle. Squeezing the handle breaks the ampoule's and starts the flow, delivering phenol to the tip and reducing exposure to the patient, physician and staff.

PART NO.	DESCRIPTION	UNITS/BOX
PH-1000	Non-sterile, single-use	10

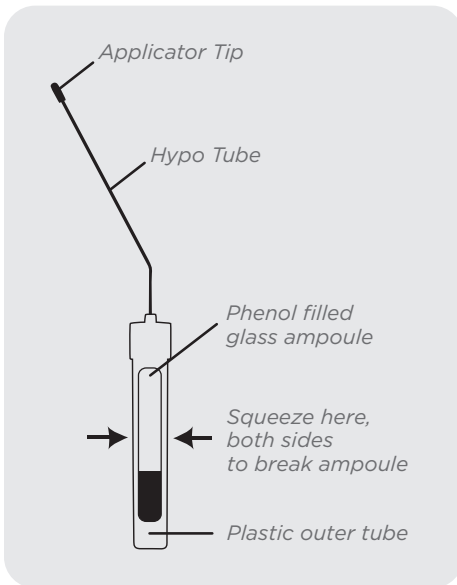

GVPRO™ GENTIAN VIOLET APPLICATOR

Apply gentian violet where you want it, when you want it there. GVPro is the first purpose built gentian violet applicator designed to improve procedural efficiency.

- Sponge-tipped hypo tube
- Pressure pinch base to start and control flow of gentian violet
- Clear visibility of anatomy

PART NO.	DESCRIPTION	UNITS/BOX
GV-1000	Non-sterile, single-use	10
GV-1000-06	Non-sterile, single-use	6

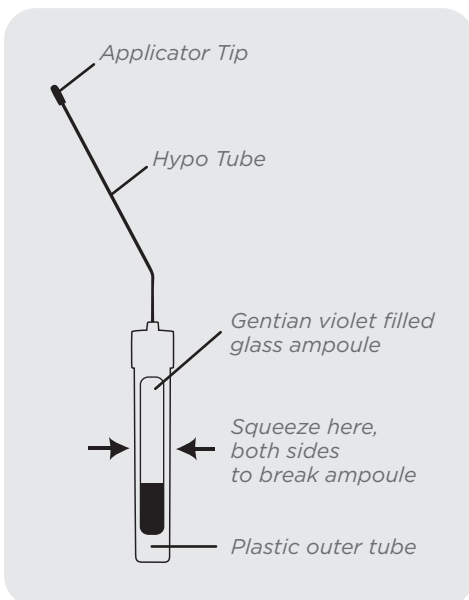

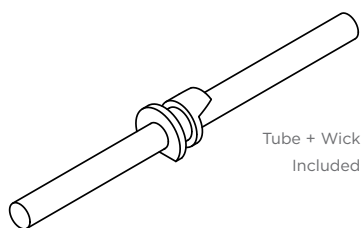
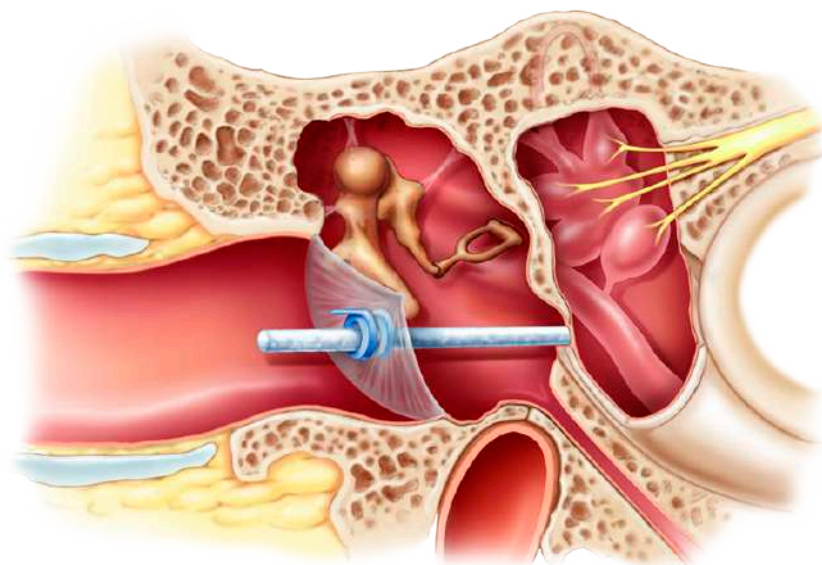

Tube + Wick
Included

SILVERSTEIN MICROWICK™ DRUG DELIVERY

The MicroWick is placed through a special ventilation tube (included) then directed to the round window membrane or orifice of the Eustachian tube. The MicroWick inserts easily prior to hydration locking securely in place after hydration.

Developed in cooperation with Dr. Herbert Silverstein. Clinical Studies available.

PART NO.	DIMENSIONS	UNITS/BOX
OT-1700	9mm x 1mm	1

ABSORBENT™ EAR PACKS + WICKS

AbsorbENT packing features three-dimensional, interconnected open cells that are soft, smooth and pliable. This interconnected structure produces a strong, highly absorbent and virtually lint-free packing.



Compressed



Hydrated

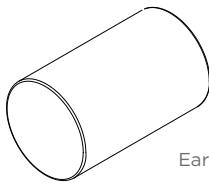

Ear Pack

EAR PACKS

PART NO.	DIMENSIONS	UNITS/BOX
OT-5203-10	15mm X 24mm	10
OT-5204-10	12mm x 24mm	10

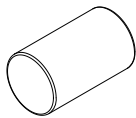

Ear Wick, 15mm

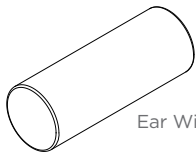

Ear Wick, 24mm

EAR WICKS

PART NO.	DIMENSIONS	UNITS/BOX
OT-5200-25	9mm x 15mm	25
OT-5201-50	9mm x 15mm	50
OT-5202-50	9mm x 24mm	50

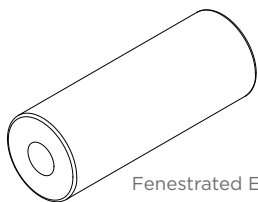

Fenestrated Ear Wick, 15mm

FENESTRATED EAR WICKS

PART NO.	DIMENSIONS	UNITS/BOX
30-305	9mm x 15mm	50



VACUTIP™ SUCTION TIPS

Designed to safely and easily remove objects from the ear and nasal cavities. Suction cup conforms to almost any shape. Disposable, non-sterile.

PART NO.	DESCRIPTION	UNITS/BOX
VA-1120	7 French suction compatible	20



VACTRACT™ SUCTION DEVICES

Complete suction device to be used with suction system to remove foreign bodies from the ear and nasal cavities. Non-sterile, single-use.

PART NO.	DESCRIPTION	UNITS/BOX
VA-1100	Suction device	5

BARON SUCTION

- Finger cut-off
- Stylette
- Length : 5 ¾"
- 3 French sizes available

PART NO.	DESCRIPTION	UNITS/BOX
SI-62-22-10	3 French	1
SI-62-22-15	5 French	1
SI-62-22-20	7 French	1



SINUS PACKING AND SPLINTING CROSS REFERENCE

All nasal and sinus packs are made from sterile, polyvinyl alcohol (PVA) foam. This chart offers easy cross referencing and ordering.

OUR PART NO.	COMPETITORS PART NUMBER	DESCRIPTION
<u>Nasal M-Type</u>		
RH-7401-10	440400/400400	M-Type Small
RH-7408-10	440409/400409	M-Type Small with Airway
RH-7404-10	440402/400402	M-Type Large
RH-7405-10	440410/400410	M-Type Large with Airway
<u>Nasal P-Type</u>		
RH-2310-10	440406 (Pope)/400406	P-Type XL
RH-2315-20	400421 (Weimert)	P-Type Small
<u>Nasal D-Type</u>		
RH-7409-10	440424 (Doyle)/400424	D-Type Wideline Anatomical
RH-7411-10	440413 (Doyle)/400413	D-Type Slimline Anatomical
<u>Sinus Nasal K & T Types</u>		
RH-7530-10	400530 (Kennedy)	K-Type, Ultra-Slim
RH-7532-10	400428 (Toffel)	T-Type, Slim
<u>Ear Packs</u>		
OT-5201-50	400141	Ear Speedi-Wick 15mm
OT-5202-50	400146	Ear Speedi-Wick 25mm
30-305	425008	Ear Fenestrated 15mm
OT-5204-10	400355	Ear Post-Op Small
OT-5203-10	400162	Ear Post-Op Large
<u>Denver® Nasal Splints</u>		
10-2000-05KL	1528136	Denver Splint, 2000 Kit Large
10-2000-05KS	1528126	Denver Splint, 2000 Kit Sm/Med
10-2000-05KP	1528116	Denver Splint, 2000 Kit Petite
10-2000-05KM	1528116	Denver Splint, 2000 Kit Mini
10-2000-10NKL	1528137/1528138	Denver Splint, 2000 Non-Kit Large
10-2000-10NKS	1528120/1528121	Denver Splint, 2000 Non-Kit Sm/Med
10-2000-05NKP	1528110/1528111	Denver Splint, 2000 Non-Kit Petite
10-2000-05NKM	1528110/1528111	Denver Splint, 2000 Non-Kit Mini
<u>Thermoplast Nasal Splints</u>		
10-4021-05KL	1529120	Denver Splint, 4000 Kit Large
10-4021-05KS	1529110	Denver Splint, 4000 Kit Sm/Med
10-4021-05KP	1529100	Denver Splint, 4000 Kit Petite
10-4021-10NKS	1529010	Denver Splint, 4000 Non-Kit Sm/Med
10-4021-10NKP	1529000	Denver Splint, 4000 Non-Kit Petite
10-4022-10NKL	1529020	Denver Splint, 4000 Non-Kit Large

ENT

Summit Medical®

Ear, Nose, and Throat Products

Innovia Medical

815 Vikings Parkway, Suite 100. St. Paul, MN 55121

T: 1-888-229-2875

www.innoviamedical.com